

Room Divider/Cubicle/ Shower Rail Systems

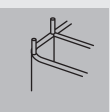



Room Divider/Cubicle/Shower Rail System

Silent Gliss® 6103

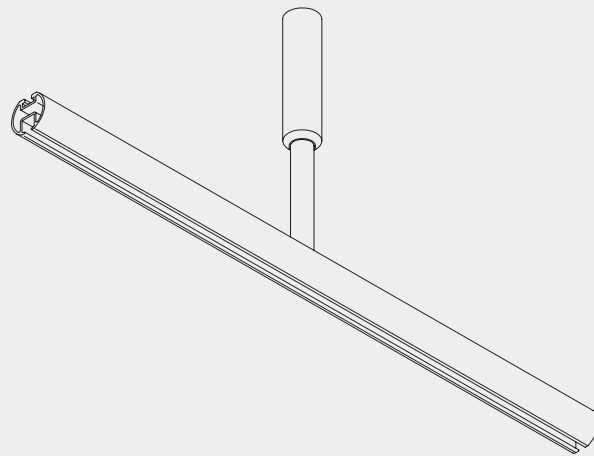

Product Information

- Attractive contemporary rounded profile shape whilst system enjoys all the flexibility and strength of the proven 6100 system
- Available as standard in silver and white. Gold and chrome available for shower rails only
- Special custom colouring facility for this profile and components enables specifiers to select a RAL colour to complement or contrast with decor
- Clean, unbroken line in hospital wards
- The top channel maximises connection positions and suspension variations. The dust-cover strip reduces the risk of cross-infection
- Standard length silver and white 6m, 7m and 7.5m (silver only), gold and chrome 4m
- Medium to heavy curtains
- Conforms to HTM66



6103

Profile, Bending and Specification Information

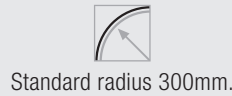
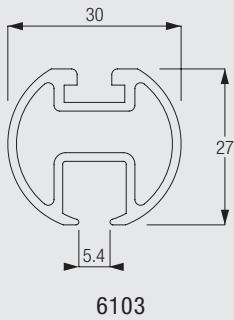

The standard bending radius is recommended for optimal performance. Minimum bending radius for 6103 is 200mm.

Specification Guide - download from www.silentgliss.co.uk (password required).

Silent Gliss 6103 room divider system, anodised aluminium rail 6103/powder coated aluminium rail 6103 in(colour), secured to fittings detailed below. Allow for noggins in suspended ceiling/hollow partitions elsewhere in B of Q.

Pre-forming bend in running length 90/135 degrees.

Dust cover 6110 fitted to track.

Nylon glider/hook 6147 fitted to track at 10/metre.

Nylon wall support 6620 twice screwed/plugged to wall and fitted to track.

Wall bracket 6503/anodised aluminiummm wide by projectionmm, each bracket screwed/plugged to wall and fitted to track.

Nylon end cover 6630 secured to track.

End stop 6007 secured to track.

Connecting bridge 6512, anodised aluminium secured to track.

T-junction 6514M, anodised aluminium secured to track.

T-junction 6525, anodised aluminium secured to track.

Ceiling fixing plate 6138, anodised aluminium once screwed through ceiling to noggin above/plugged and screwed and secured to track.

Twist fixing plate 6124 twice screwed/plugged to ceiling and secured to track.

6190 Hanger, anodised aluminium assembly dropm once screwed through ceiling to noggin above (noggin by others)/plugged and screwed and secured to track.

6501 V-hanger, anodised aluminium assembly dropm twice screwed through ceiling noggins above (noggins by others)/plugged and screwed and secured to track.



6103

System Layout Options

As a universal room divider/shower rail system with various accessories, there are few limits to size and layouts.

Typical layout for hospital (without V-hangers)

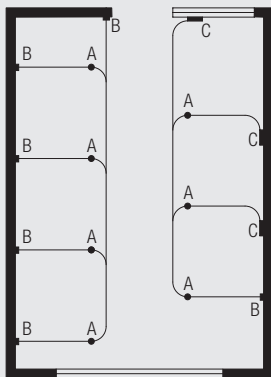

A: hanger rod 6190
B: wall support 6620
C: bracket 6503

Typical method obtaining stability by attaching cubicles to corridor (or window) wall.

Typical layout for hospital (with use of V-hangers)

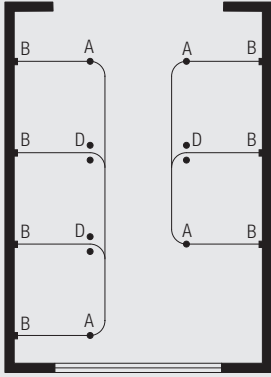

A: hanger rod 6190
 B: wall support 6609
 D: V-hanger 6501

Lateral stability in any cubicle layouts is essential to prevent weakening of the wall and ceiling fixtures by lateral movement. Where it is not practical to fit tie bars, etc., stability may be obtained by the incorporation of V-hangers to the ceiling as shown in the diagram above.

Fitting Information

The System 6103 is normally ceiling and wall fixed on suspended hangers and special wall brackets.

Site preparation for suspended ceiling applications

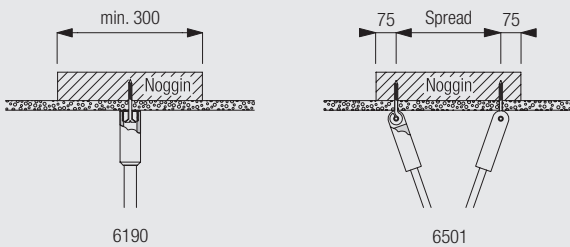

Fixings should support the ends of the profile and any changes in direction. Maximum span between fixings is 300mm.

When fitting to suspended ceilings site preparation is critical. At each hanger position a noggin in approved material is required above the suspended ceiling; underside to rest on top of ceiling (but independently supported) with a minimum length of 300mm at right angles to the track in which the hanger occurs to give fixing tolerance. Ideally the hangers should be on the return track, if on the front track then adequate support should be provided. A detailed information sheet is available on request.



6103

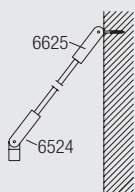

Diagonal fixing supports can be used to return the hanger to the bedhead wall, but only for use when it is impossible to ceiling fix.

Dust Cover Strip

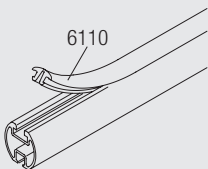

Dust cover strip 6110 for proile 6103 reduces the risk of infection.

Fitting Options

Ceiling fix with fixing plate

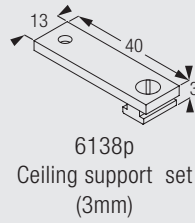
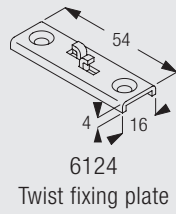
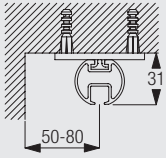

Fixing plate positioning is recommended to be at maximum 300mm intervals.

Ceiling fix with ceiling support 6175

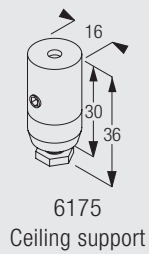
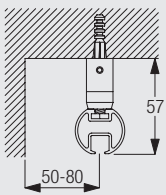

Bracket positioning is recommended to be at maximum 300mm intervals.

Ceiling fix with hanger 6190

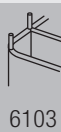

6103

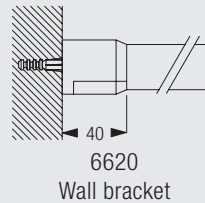
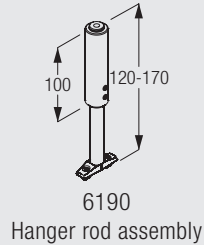
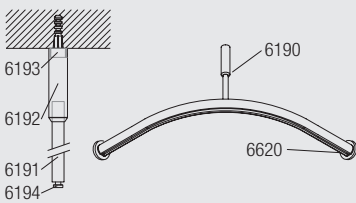

Can also be fixed through suspended ceilings by using special sleeves 6197, 6187, 6188.

Ceiling fix with V-hanger 6501

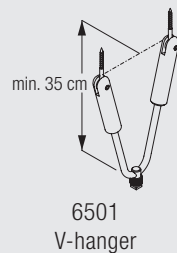
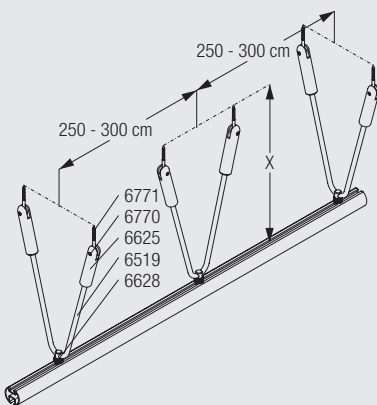

Wall fix with bracket 6503

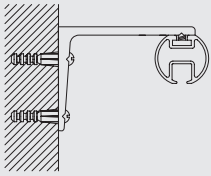

	mm	mm		mm
6503a	25x50	6503b	50x50	
6503c	50x100	6503d	100x50	
6503e	200x50	6503f	100x100	
6503g	75x150			

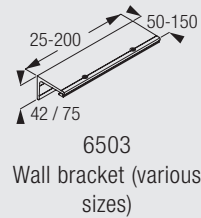

Wall fix with special wall support 0550A for traditional shower rail

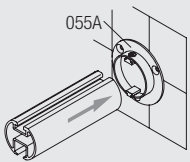

Standard Accessories

3582	Hook		0550A	Special support (chrome and gold only)	
6007	Endstop		6065	Twist eye endstop	
6086	Spring stop		6094	Roller glider with hook	
6096	Glider 6083 in strip form		6098	Roller glider with eye	
6103	Profile		6110	Dust cover	
6124	Twist fixing plate		6143	Glider 6144 in strip form	
6146	Hook		6147	Glider 6144 with hook 6146 in strip form	
6175	Ceiling support		6283	Roller glider	
6503	Wall bracket (various sizes)		6514	T-Junction	
6521	External bridge		6525	Cross connection	
6620	Wall bracket		6630	Endcover (ø32.5mm)	

6631 Connecting piece 

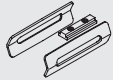
6635 Internal connecting bridge assembly 

6138p Ceiling support set (3mm) 

Sets

6190 Hanger rod assembly

6194 Track insert

1



6191 Hanger rod

1

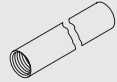

6192 Sleeve

1



6193 Ceiling stud

1



6501 V-hanger assembly

6625 Complete fixing sleeve

1



6770 Locking pin

1



6771 Vine eye

1



6519 Hanger rod

1



6628 V-hanger track insert

1



6103

Optional Accessories

6160 Connecting piece



6187 Dummy ceiling support sleeve



6188 Ceiling support



6197 Hanger joint sleeve



6524 Diagonal fixing support



6625 Complete fixing sleeve



Useful Information

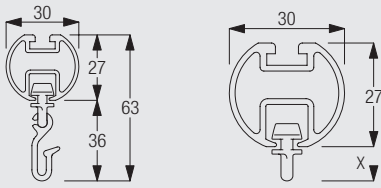

The left hand diagram illustrates the standard measurements for 6103 cubicle/shower system with combined 6147 glider/hook. For non-medical application refer to the right hand illustration and the figures below for the roller/glider dimensions.

6083 = 7mm

6094 = 31mm

6098 = 26mm

6283 = 7mm

6144 = 9mm



6103



6103



6103

www.bradingfabrication.com

Brading Fabrication Limited
1885 Clements Road, Unit 228
Pickering, ON, Canada
L1W 3V4

Tel: 289-372-3014

info@bradingfabrication.com