

SG 1080

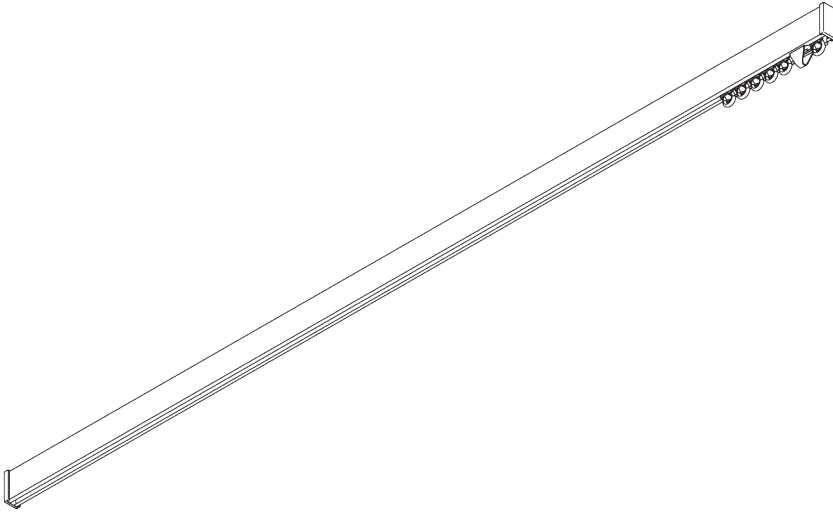

PRODUCT INFORMATION

- **Operation:** hand
- **Range:** S
- **Fitting:** ceiling, wall, suspended
- **Colours:** white RAL 9016, black RAL 9005 or anodised aluminum, special colours possible
- **Fabrics:** refer to Silent Gliss fabric collection

Features:

- Bendable

SYSTEM SPECIFICATIONS

A. PROFILE

Profile and bending information

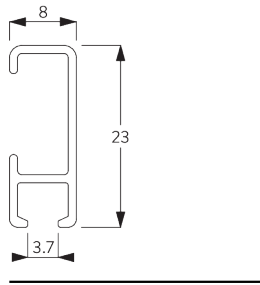

SG 1080p

Profile

Radius:
✓ 6 cm, 10 cm, >30 cm

B. HOW TO MEASURE

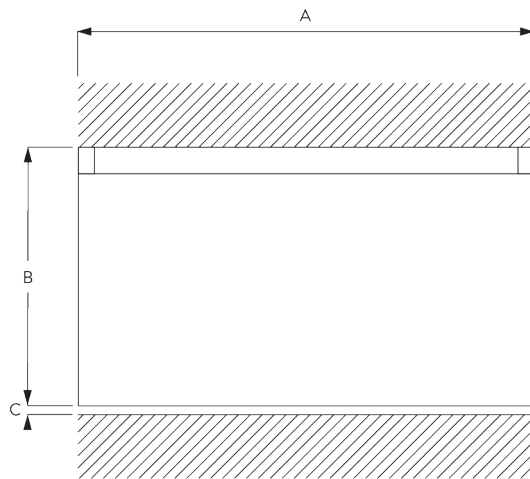

A: System width
B: System height
C: Distance between floor and fabric

C. SPECIFICATION

TEXT

Silent Gliss SG 1080 Hand Drawn Curtain Track System. Comprises aluminium profile SG 1080 supplied made to measure in silver anodised or powder coated white / matt white / anodic grey / antique bronze / charcoal / black with gliders SG 3533 at 16/m and 2 end covers SG 3667 / end stops SG 3016 per length. Top fixed with brackets SG 3603 at max. 600mm centres / wall fix with universal brackets SG 3630 / SG 3655 / SG 3660 / SG Smart Fix at max. 600mm centres.

FITTING

A. FITTING INFORMATION

Fixing points

For detailed fitting information, visit the [Silent Gliss website](#).

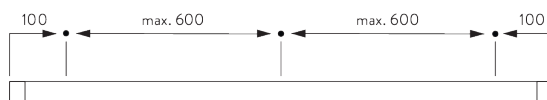

B. CEILING FITTING

Bracket SG 3603

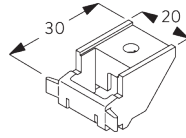
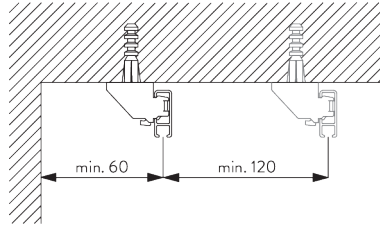

SG 3603
Bracket

C. WALL FITTING

Smart Fix

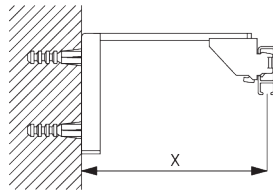

Smart Fix SG 11200 - SG 11205 and bracket SG 3603:
Screw SG 10492 (M4x8) needed.

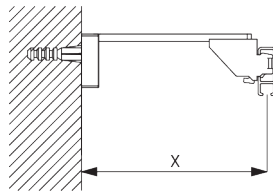

Square Smart Fix SG 11210 - SG 11215 and bracket SG 3603:
Screw SG 10492 (M4x8) needed.

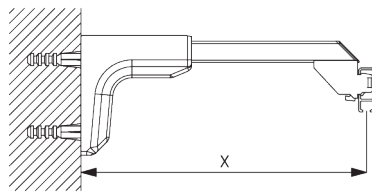

Universal Smart Fix SG 11154 - SG 11156 and bracket SG 3603:
Screw SG 10277 (M4x12) needed.

Smart Fix	X mm
SG 11200 / SG 11210	70
SG 11201 / SG 11211	90
SG 11202 / SG 11212	110
SG 11203 / SG 11213	130
SG 11204 / SG 11214	160
SG 11205 / SG 11215	210
SG 11154	120-148
SG 11155	150-178
SG 11156	200-228

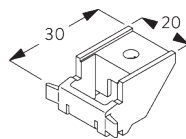

SG 3603
Bracket



SG 10492
Pan head screw M4x8



SG 10277
Pan head screw M4x12

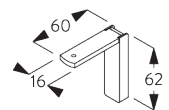

SG 11200
Smart Fix 60 mm

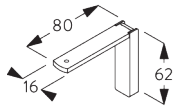

SG 11201
Smart Fix 80 mm

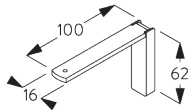

SG 11202
Smart Fix 100 mm

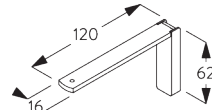

SG 11203
Smart Fix 120 mm

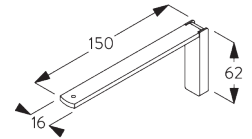

SG 11204
Smart Fix 150 mm

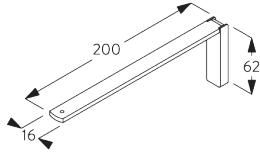

SG 11205
Smart Fix 200 mm

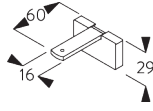

SG 11210
Square Smart Fix 60 mm

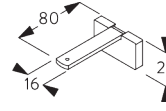

SG 11211
Square Smart Fix 80 mm

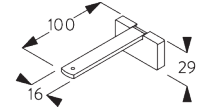

SG 11212
Square Smart Fix 100 mm

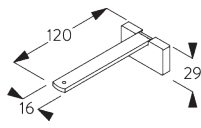

SG 11213
Square Smart Fix 120 mm

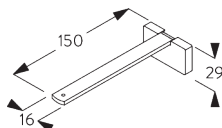

SG 11214
Square Smart Fix 150 mm

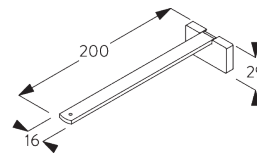

SG 11215
Square Smart Fix 200 mm

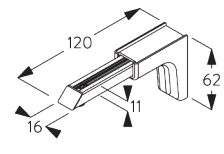

SG 11154
Universal Smart Fix 120 mm

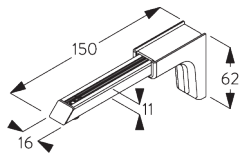

SG 11155
Universal Smart Fix 150 mm

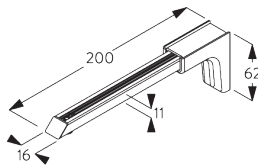

SG 11156
Universal Smart Fix 200 mm

**Universal brackets
SG 3630, SG 3655,
SG 3660**

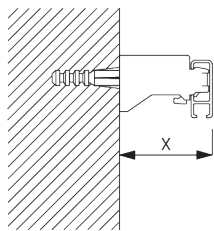

Bracket	X mm
SG 3630	33
SG 3655	48
SG 3660	63

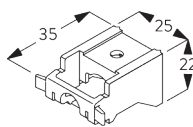

SG 3630
Bracket 35 mm

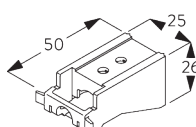

SG 3655
Bracket 50 mm

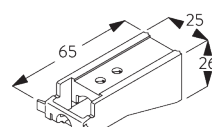

SG 3660
Bracket 65 mm

**D. SUSPENDED
FITTING**

**Hanger SG 3639 /
wall support SG 3602**

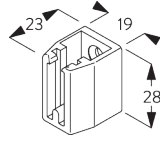
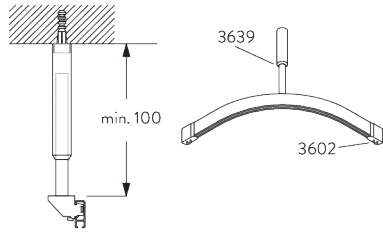

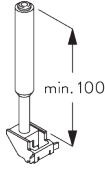

SG 3602
Wall support









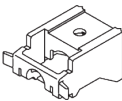
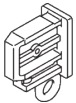



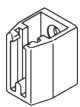

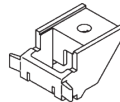

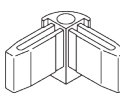

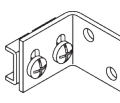

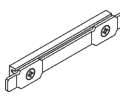

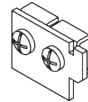

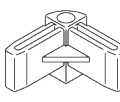

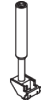
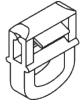
SG 3639
Hanger

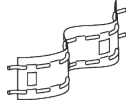
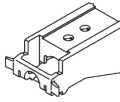
PARTS

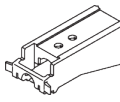
A. STANDARD PARTS

	SG 1080p Profile
	SG 3533 Glider
	SG 3630 Bracket 35 mm
	SG 3667 End cover

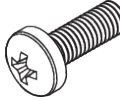
B. OPTIONAL PARTS

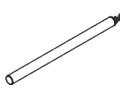
	SG 3016 End stop		SG 3602 Wall support
	SG 3020 Hook		SG 3603 Bracket
	SG 3032 Spring stop		SG 3604 Corner connector
	SG 3070 End stop		SG 3618 Wall bracket
	SG 3071 End stop		SG 3620 Connection bridge
	SG 3151 Spacer		SG 3626 Return holder
	SG 3511 Glider		SG 3638 Corner connector
	SG 3534 Glider 3533 on strip		SG 3639 Hanger
	SG 3548 Glider		SG 3648 Eyelet
	SG 3562 Heading tape		SG 3655 Bracket 50 mm
	SG 3570 Glider		SG 3660 Bracket 65 mm
	SG 3571 Hook		SG 6146 Hook
	SG 3582 Hook		SG 10277 Pan head screw M4x12
	SG 3599 Hook		SG 10430 Draw rod 50 cm

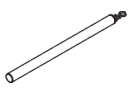

SG 10431

Draw rod 75 cm



SG 10432

Draw rod 100 cm

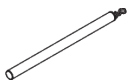

SG 10433

Draw rod 125 cm

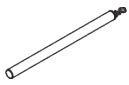

SG 10434

Draw rod 150 cm



SG 10492

Pan head screw M4x8

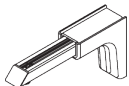

SG 11154

Universal Smart Fix 120 mm

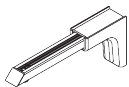

SG 11155

Universal Smart Fix 150 mm

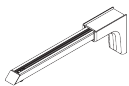

SG 11156

Universal Smart Fix 200 mm

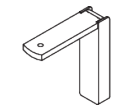

SG 11200

Smart Fix 60 mm

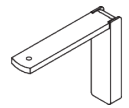

SG 11201

Smart Fix 80 mm

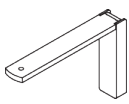

SG 11202

Smart Fix 100 mm

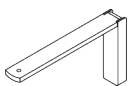

SG 11203

Smart Fix 120 mm

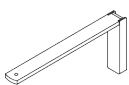

SG 11204

Smart Fix 150 mm



SG 11205

Smart Fix 200 mm

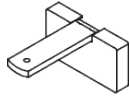

SG 11210

Square Smart Fix 60 mm

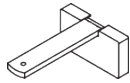

SG 11211

Square Smart Fix 80 mm

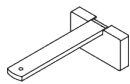

SG 11212

Square Smart Fix 100 mm

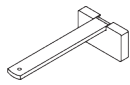

SG 11213

Square Smart Fix 120 mm

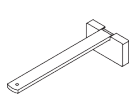

SG 11214

Square Smart Fix 150 mm

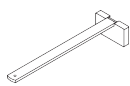

SG 11215

Square Smart Fix 200 mm

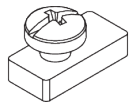

SG 11335

End stop

www.bradingfabrication.com

Brading Fabrication Limited
1885 Clements Road, Unit 228
Pickering, ON, Canada
L1W 3V4

Tel: 1-800-483-5550

info@bradingfabrication.com