

SG 2190

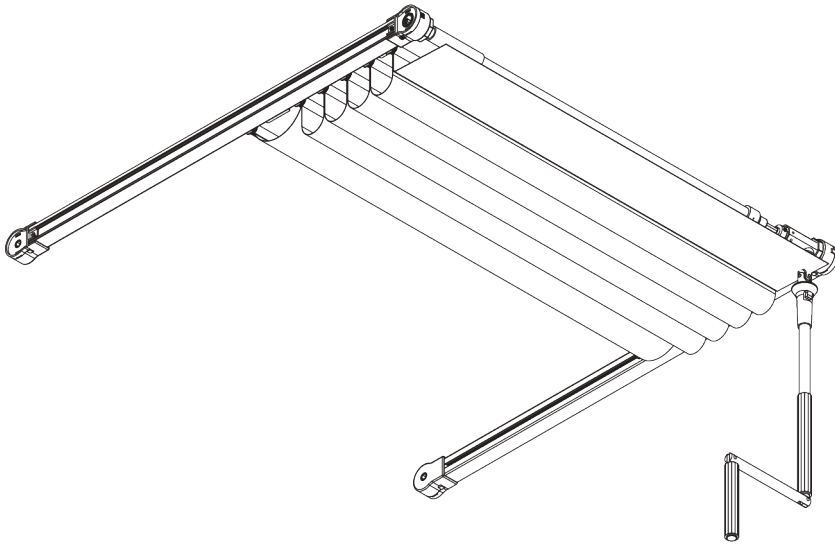
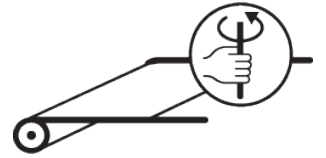

PRODUCT INFORMATION

- **Operation:** crank
- **Range:** S - M
- **Fitting:** ceiling, wall
- **Colours:** white RAL 9016 or anodised aluminum, special colours possible
- **Fabrics:** refer to Silent Gliss fabric collection

Features:

- Bendable
- Sloping
- Two connected systems

SYSTEM SPECIFICATIONS

A. SYSTEM DIMENSIONS

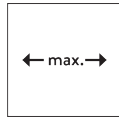

2.5 m

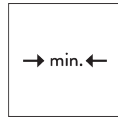

60 cm

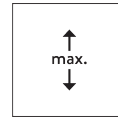

6 m



15 kg

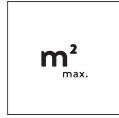

15 m²

Max. system sizes and weights

| SG 2190 | | kg _{max.} | A | B | SG 2190 | | kg _{max.} | A | B |
|---------|--|--------------------|-------|-----|---------|--|--------------------|-----|-----|
| | | 15 | 1.8 m | 6 m | | | 15 | 2 m | 5 m |
| | | 15 | 1.8 m | 6 m | | | 15 | 2 m | 5 m |
| | | 15 | 2 m | 5 m | | | 15 | 2 m | 5 m |
| | | 15 | 2 m | 5 m | | | 15 | 2 m | 4 m |
| | | 15 | 2.5 m | 6 m | | | 15 | 2 m | 4 m |
| | | 15 | 3 m | 6 m | | | 15 | 2 m | 4 m |

B. PROFILE

Profile and bending information

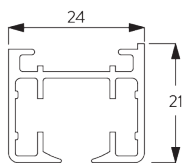

SG 2191

Profile

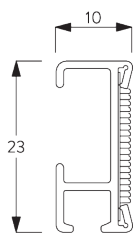

SG 2116

Velcro profile



SG 2156

Shaft



SG 2759

Profile

C. HOW TO MEASURE

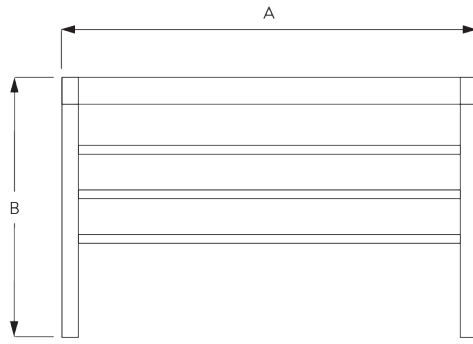

A: System width
B: System height

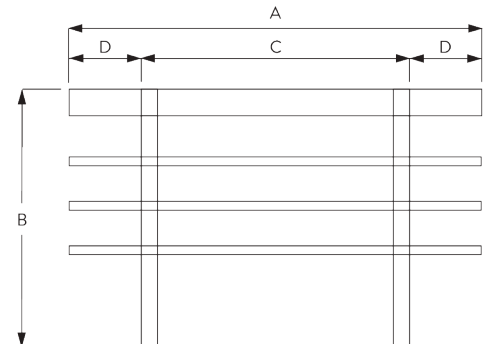

A: System width
B: System height
C: Base system
D: Cantilever max. 80 cm

D. SPECIFICATION TEXT

Silent Gliss SG 2190 Crank Handle Operated Skylight System. Supplied made to measure and complete comprising drive shaft SG 2156, detachable crank handle SG 2746, hexagonal bar SG 2111, glider SG 2145, heavy duty cross rod SG 2248, cross rod SG 2759, velcro profile SG 2116, connector SG 2242, top fix bracket SG 3603, aluminium side guide profiles SG 2191 in silver / white / black side fixed with SG 3825 clamps at 30cm centres. Optional fixing brackets SG 3065B / SG 3066A / SG3066B. Left- or right-hand operation. Can be single or double system operated from single crank handle. Fabric to be chosen from the Silent Gliss fabric range relevant for this product type.

FITTING

A. FITTING INFORMATION

For detailed fitting information, visit the Silent Gliss website.

Fixing points

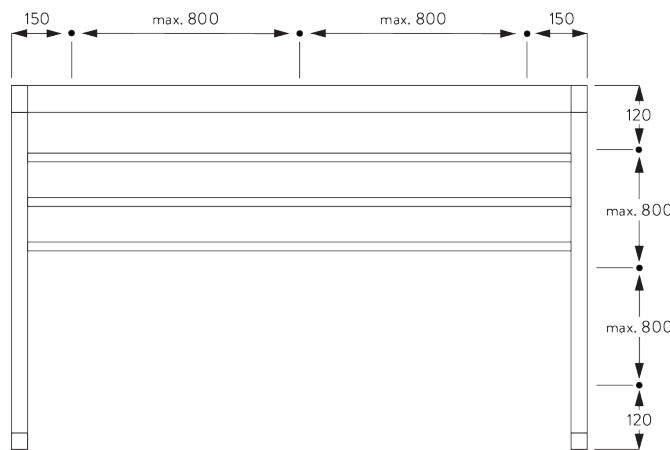

B. INSIDE FITTING

Clamp SG 3825

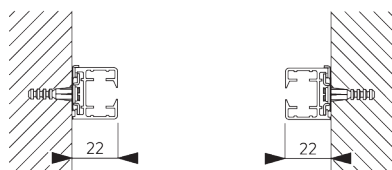

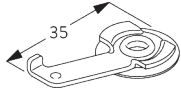

SG 3825

Clamp

C. FACE FITTING

Bracket SG 3181

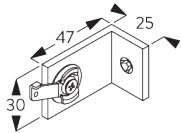
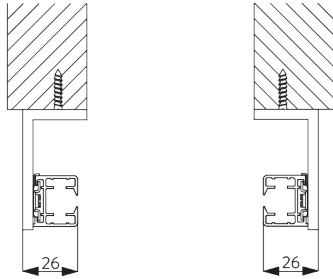

SG 3181

Bracket with 1 clamp

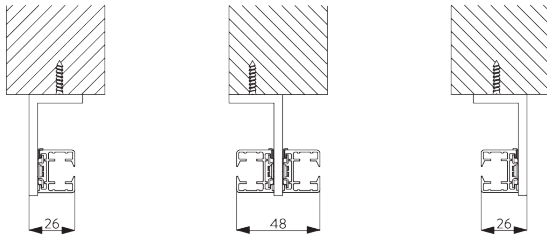

Double system

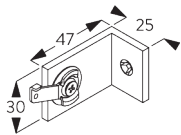

SG 3181

Bracket with 1 clamp

T-Bracket SG 2138 / SG 2139

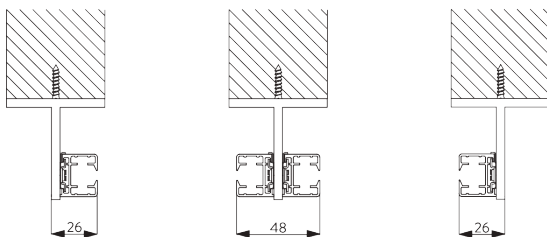

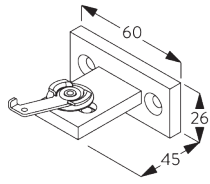

SG 2138
T-bracket 1 clamp

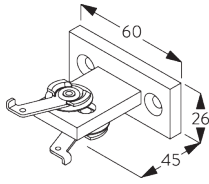

SG 2139
T-bracket 2 clamps

SYSTEM OPTIONS

A. TWO CONNECTED SYSTEMS

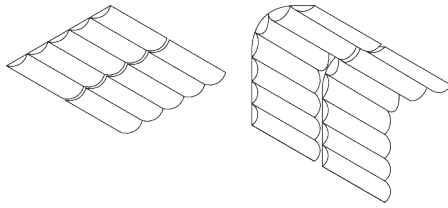

B. INSTALLATION OPTIONS

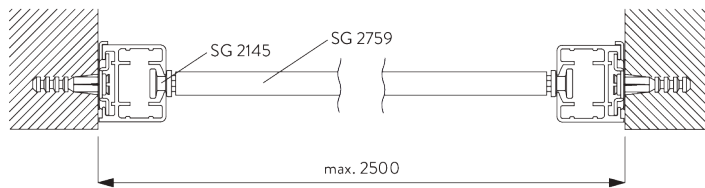

- SG 2145: Glider
- SG 2759: Profile

C. FABRIC FIXING

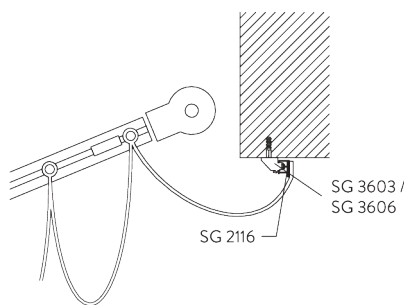

Fixing of fabric with profile SG 2116

PARTS

A. STANDARD PARTS



SG 2111

Shaft

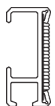

SG 2116

Velcro profile

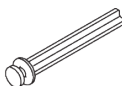

SG 2145

Glider



SG 2156

Shaft

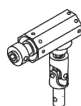

SG 2189

Crank drive

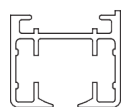

SG 2191

Profile

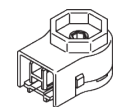

SG 2192

Drive

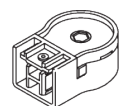

SG 2193

Guide return

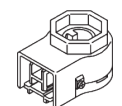

SG 2230

Drive

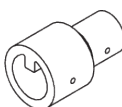

SG 2244

Connector

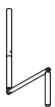

SG 2747

Crank handle

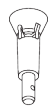

SG 2754

Detachable crank hood



SG 3825

Clamp

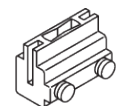

SG 5005

Belt connector

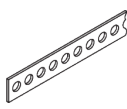

SG 5130

Driving belt

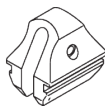

SG 6086

Spring stop

B. OPTIONAL PARTS

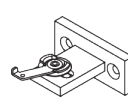

SG 2138

T-bracket 1 clamp

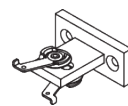

SG 2139

T-bracket 2 clamps



SG 2176

Crank drive

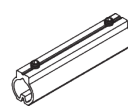

SG 2242

Connector

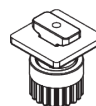

SG 2255

Brake

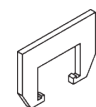

SG 2613

Connector



SG 2742

Crank joint

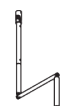

SG 2745

Crank handle with joint

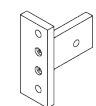

SG 3066

T-Bracket

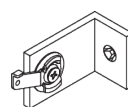

SG 3181

Bracket with 1 clamp



SG 3606

Clip

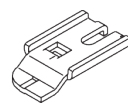

SG 3832

Bracket



SG 5115

Connection bridge

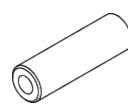

SG 6796

Spring pin 4x12 DIN 1481

www.bradingfabrication.com

Brading Fabrication Limited
1885 Clements Road, Unit 228
Pickering, ON, Canada
L1W 3V4

Tel: 1-800-483-5550

info@bradingfabrication.com