

# SG 2730

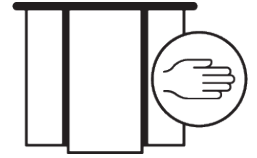

## FLEX

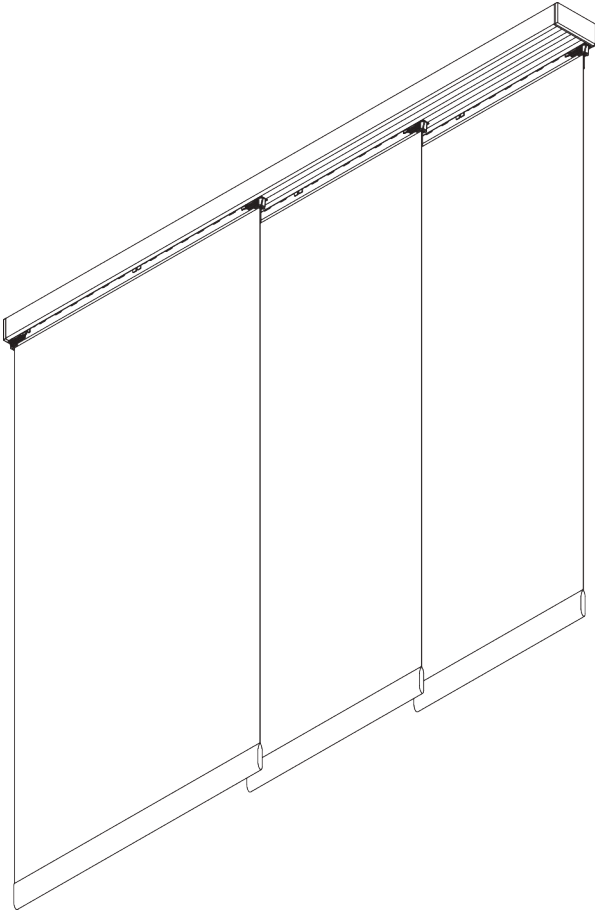

### PRODUCT INFORMATION

- **Operation:** hand
- **Range:** S - L
- **Fitting:** ceiling, wall
- **Colours:** white RAL 9016; special colours or anodised aluminum possible
- **Fabrics:** refer to Silent Gliss fabric collection

#### **Features:**

- 2-component (2C) roller technology
- Silent and smooth running
- Free floating or connected panels
- Bendable

# SYSTEM SPECIFICATIONS

## A. SYSTEM DIMENSIONS



Panels free floating:  
unlimited  
Panels connected: 6 m

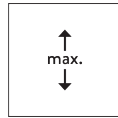

3 m



Max. 2 kg per m

## B. PROFILE

Profile and bending information

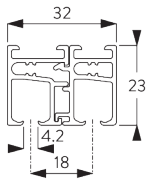

**SG 10132**

Profile 2-channel

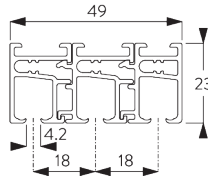
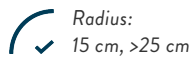

**SG 10133**

Profile 3-channel

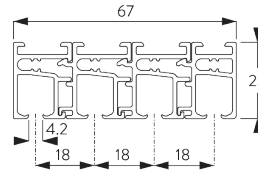
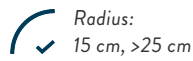

**SG 10134**

Profile 4-channel

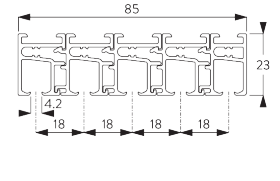
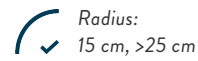

**SG 10135**

Profile 5-channel

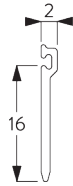
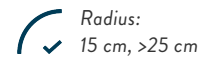

**SG 10179**

Profile



**SG 10180**

Carrier flexible

## C. HOW TO MEASURE

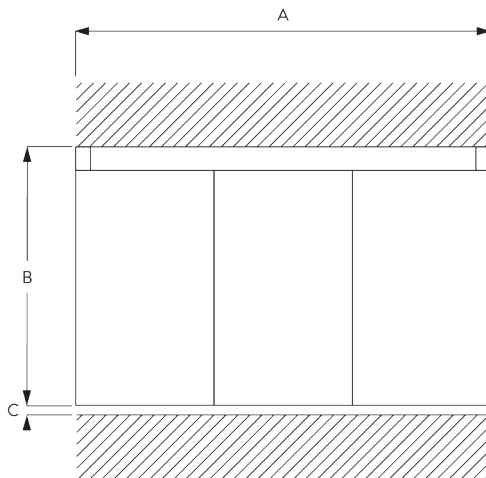

A: System width

B: System height

C: Distance between floor and fabric

## Dimensions of Panels

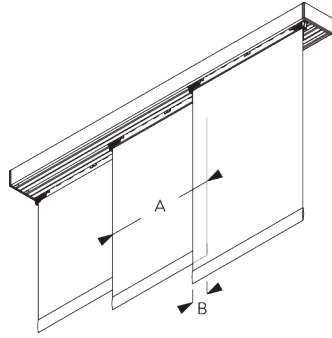

### Free floating:

A: Recommended panel width: 500 - 1200

### Connected:

A: Recommended panel width: 500 - 1200

B: Overlap: min. 50

## D. SPECIFICATION TEXT

**Silent Gliss SG 2730 Flex Panel Glide System.** Curved panel glide system supplied made to measure and complete comprising profiles SG 10132 / SG 10133 / SG 10134 / SSG 10135 as necessary with carrier SG 10180 with associated components and flexible lead bottom weight SG 10233. Fabric panels stack right hand single / left hand single / pair / centre. Hand operated with panels unconnected / connected using draw rod SG 10430 / SG 10431 / SG 10432 / SG 10433 / SG 10434. Ceiling fix direct with suitable screw. Wall fix with Smart Fix brackets SG 11206-11208 / Square Smart Fix brackets SG 11216 - 11218 with slot nut SG 10160. Fabric to be chosen from Silent Gliss fabric collection, Price Group 1 / 2 / 3.

# FITTING

## A. FITTING INFORMATION

For detailed fitting information, visit the Silent Gliss website.

### Fixing points

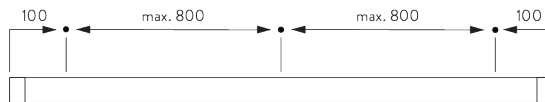

## B. CEILING FITTING

### Direct fitting

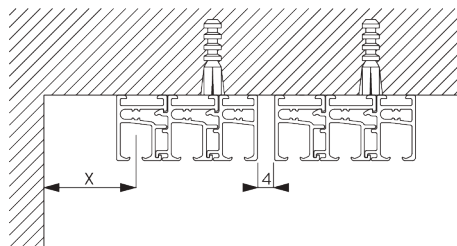

X = depending on room conditions

## C. WALL FITTING

### Smart Fix

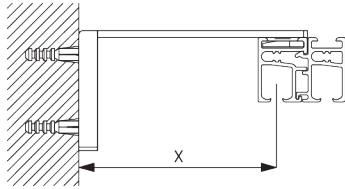

**Smart Fix with slot SG 11206 - SG 11208:**  
Screw SG 10395 (M4x6) needed.

Smart Fix	X mm (SG 10132)	X mm (SG 10133)	X mm (SG 10134)	X mm (SG 10135)
SG 11206 / SG 11216	50	32	-	-
SG 11207 / SG 11217	70	52	34	-
SG 11208 / SG 11218	90	72	44	on request

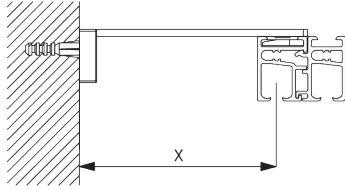

**Square Smart Fix with slot SG 11216 - SG 11218:**  
Screw SG 10395 (M4x6) needed.

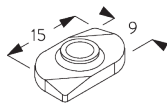

**SG 10160**  
Slot nut



**SG 10395**  
Pan head screw M4x6

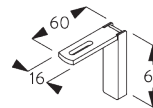

**SG 11206**  
Smart Fix with slot 60 mm

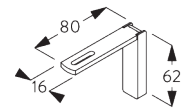

**SG 11207**  
Smart Fix with slot 80 mm

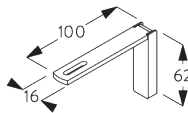

**SG 11208**  
Smart Fix with slot 100 mm

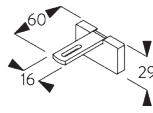

**SG 11216**  
Square Smart Fix with slot 60 mm

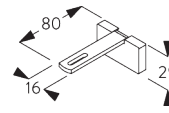

**SG 11217**  
Square Smart Fix with slot 80 mm

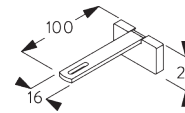

**SG 11218**  
Square Smart Fix with slot 100 mm

# SYSTEM OPTIONS

## A. OPERATION

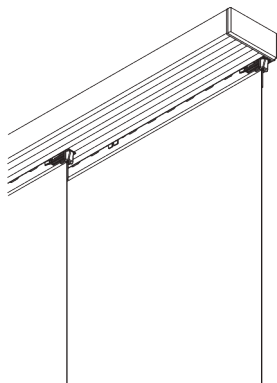

Free floating (unconnected panels)

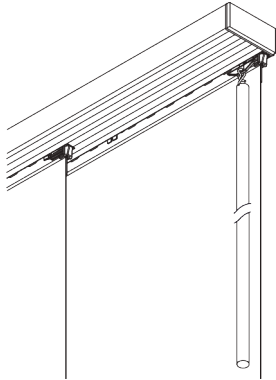

**B. PANEL STACKING  
(CONNECTED)**



Single stack  
Note: dot = fixed panel



Pair stack  
Other variations are possible. Same splitting for curved profiles.

Note: dot = fixed panel

# PARTS

## A. STANDARD PARTS

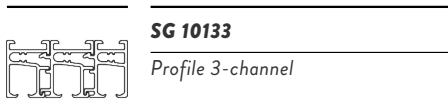

**SG 10133**

Profile 3-channel



**SG 10159**

Countersunk head screw 3.5x13



**SG 10163**

End cover

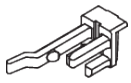

**SG 10167**

Clip left

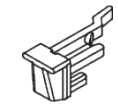

**SG 10168**

Clip right



**SG 10179**

Profile



**SG 10180**

Carrier flexible

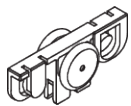

**SG 10200**

2C roller

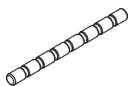

**SG 10233**

Lead weight 100 gr/m

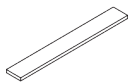

**SG 10234**

Fabric weight glass

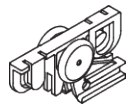

**SG 10237**

Clip holder



**SG 10248**

Screw Pozi 4.5x70 mm SPAX

## B. OPTIONAL PARTS

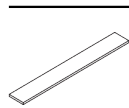

**SG 10076**

Fabric weight

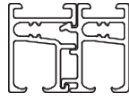

**SG 10132**

Profile 2-channel

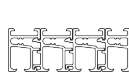

**SG 10134**

Profile 4-channel



**SG 10135**

Profile 5-channel

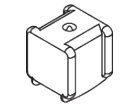

**SG 10156**

End stop

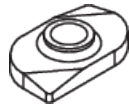

**SG 10160**

Slot nut



**SG 10162**

End cover



**SG 10164**

End cover



**SG 10165**

End cover



**SG 10177**

Connection bridge

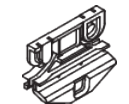

**SG 10196**

Eyelet for draw rod



**SG 10235**

Sticker for screw head

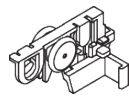

**SG 10239**

Angle left

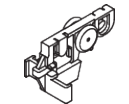

**SG 10241**

Angle right



**SG 10243**

Angle



**SG 10244**

Slider



**SG 10281**

Hexagon socket head cap screw M4x6



**SG 10395**

Pan head screw M4x6

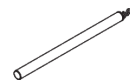

**SG 10430**

Draw rod 50 cm



**SG 10431**

Draw rod 75 cm

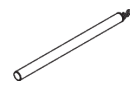

**SG 10432**

Draw rod 100 cm



**SG 10433**

Draw rod 125 cm

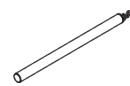

**SG 10434**

Draw rod 150 cm

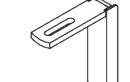

**SG 11206**

Smart Fix with slot 60 mm

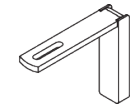

**SG 11207**

Smart Fix with slot 80 mm

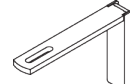

**SG 11208**

Smart Fix with slot 100 mm

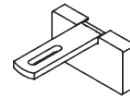

**SG 11216**

Square Smart Fix with slot 60 mm

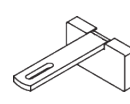

**SG 11217**

Square Smart Fix with slot 80 mm

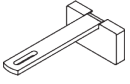

**SG 11218**

*Square Smart Fix with slot 100 mm*

---

[www.bradingfabrication.com](http://www.bradingfabrication.com)

Brading Fabrication Limited  
1885 Clements Road, Unit 228  
Pickering, ON, Canada  
L1W 3V4

Tel: 1-800-483-5550

[info@bradingfabrication.com](mailto:info@bradingfabrication.com)